

COMP 322, Lab 5

Goals for this Lab

Gain experience working with the NOTS compute cluster and the Unix shell.

Explore loop parallelism with HJlib and Java Parallel Streams.

NOTS

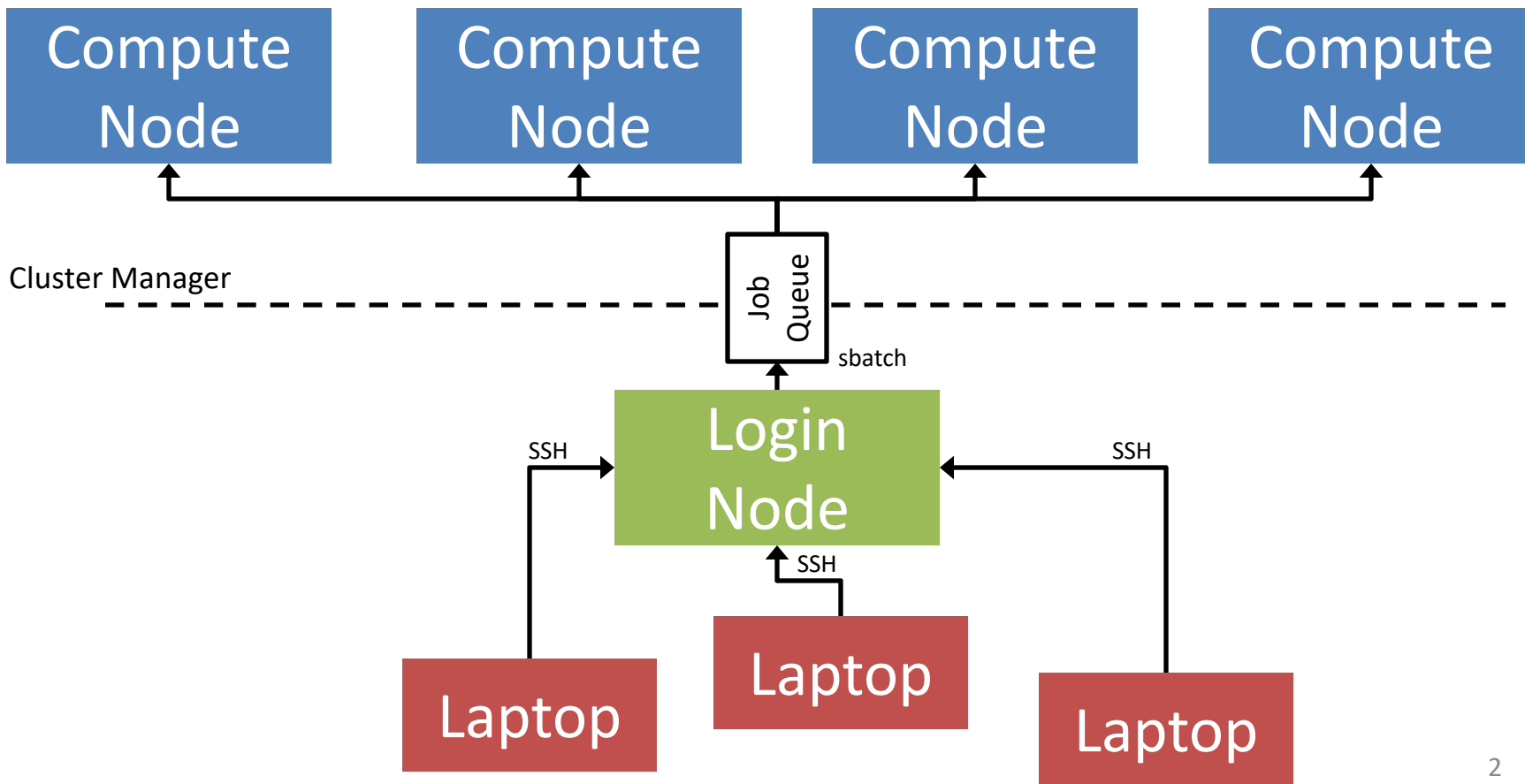

Shell Introduction

Lab handout includes a brief introduction to some useful commands (with pointers to other references).

No required tasks related to the shell for this lab, purely for your benefit.

Feel free to grab a TA if you have questions about the shell.

Loop Parallelism in Image Convolution

Apply a transformation kernel to an image to produce a new image (see the lab handout for a link to more background info).



$$+ \begin{pmatrix} 0 & -1 & 0 \\ -1 & 5 & -1 \\ 0 & -1 & 0 \end{pmatrix} =$$

