

COMP 322: Fundamentals of Parallel Programming

Lecture 17: Midterm Review

Mack Joyner and Zoran Budimlić
{mjoyner, zoran}@rice.edu

<http://comp322.rice.edu>



Worksheet #16:

Reordered Asyncns with One Phaser

Name: _____

Netid: _____

Task A4 has been moved up to line 6. Does this change the computation graph in slide 7? If so, draw the new computation graph. If not, explain why the computation graph is the same.

No, A4 still needs to wait on A2 and A3 to signal before it can start doA4Phase2().

```
1. finish (() -> {
2.     ph = newPhaser(SIG_WAIT); // mode is SIG_WAIT
3.     asyncPhased(ph.inMode(SIG), () -> {
4.         // A1 (SIG mode)
5.         doA1Phase1(); next(); doA1Phase2(); });
6.     asyncPhased(ph.inMode(HjPhaserMode.WAIT), () -> {
7.         // A4 (WAIT mode)
8.         doA4Phase1(); next(); doA4Phase2(); });
9.     asyncPhased(ph.inMode(SIG_WAIT), () -> {
10.        // A2 (SIG_WAIT mode)
11.        doA2Phase1(); next(); doA2Phase2(); });
12.    asyncPhased(ph.inMode(HjPhaserMode.SIG_WAIT), () -> {
13.        // A3 (SIG_WAIT mode)
14.        doA3Phase1(); next(); doA3Phase2(); });
15. });
```



Async and Finish Statements for Task Creation and Termination (Lecture 1)

async S

- Creates a new child task that executes statement S

```
// T0 (Parent task)
STMT0;
finish { //Begin finish
  async {
    STMT1; //T1 (Child task)
  }
  STMT2; //Continue in T0
          //Wait for T1
} //End finish
STMT3; //Continue in T0
```

finish S

- Execute S, but wait until *all* asyncs in S's scope have terminated.

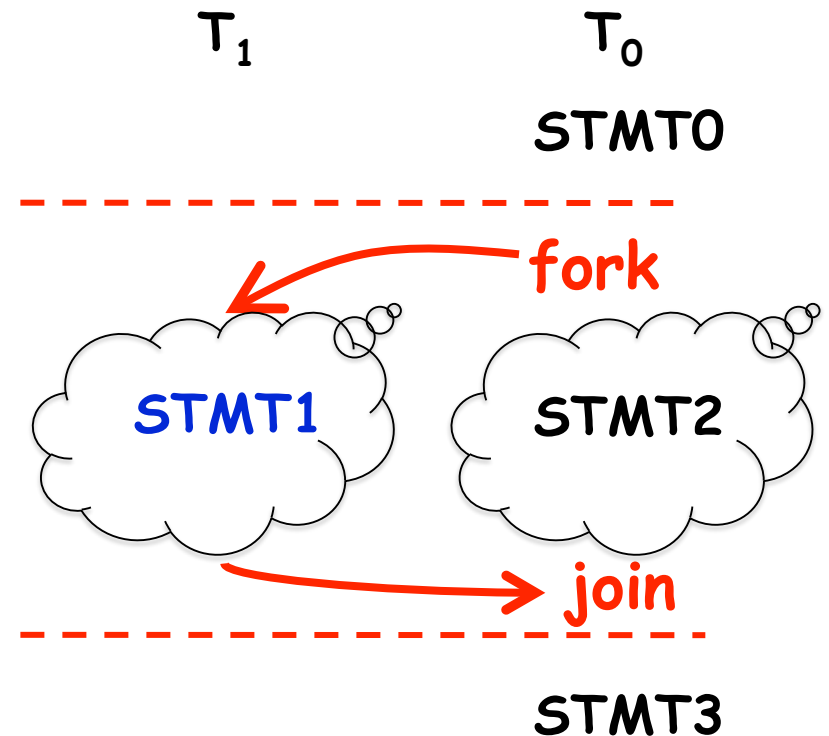

One Possible Solution to Problem #2 in Worksheet 1 (Parallel Matrix Multiplication)

```
1. finish {
2.   for (int i = 0 ; i < N ; i++)
3.     for (int j = 0 ; j < N ; j++)
4.       async {
5.         for (int k = 0 ; k < N ; k++)
6.           C[i][j] = C[i][j] + A[i][k] * B[k][j];
7.       } // async
8.} // finish
```

This program generates N^2 parallel async tasks, one to compute each $C[i][j]$ element of the output array. Additional parallelism can be exploited within the inner k loop, but that would require more changes than inserting `async` & `finish`.



Computation Graphs (Lecture 2)

- A Computation Graph (CG) captures the dynamic execution of a parallel program, for a specific input
- CG nodes are “steps” in the program’s execution
 - A step is a sequential subcomputation without any async, begin-finish and end-finish operations
- CG edges represent ordering constraints
 - “Continue” edges define sequencing of steps within a task
 - “Spawn” edges connect parent tasks to child async tasks
 - “Join” edges connect the end of each async task to its IEF’s end-finish operations
- All computation graphs must be acyclic
 - It is not possible for a node to depend on itself
- Computation graphs are examples of “directed acyclic graphs” (dags)



Which statements can potentially be executed in parallel with each other?

```
1. finish { // F1
2.   async A;
3.   finish { // F2
4.     async B1;
5.     async B2;
6.   } // F2
7.   B3;
8. } // F1
```

Computation Graph

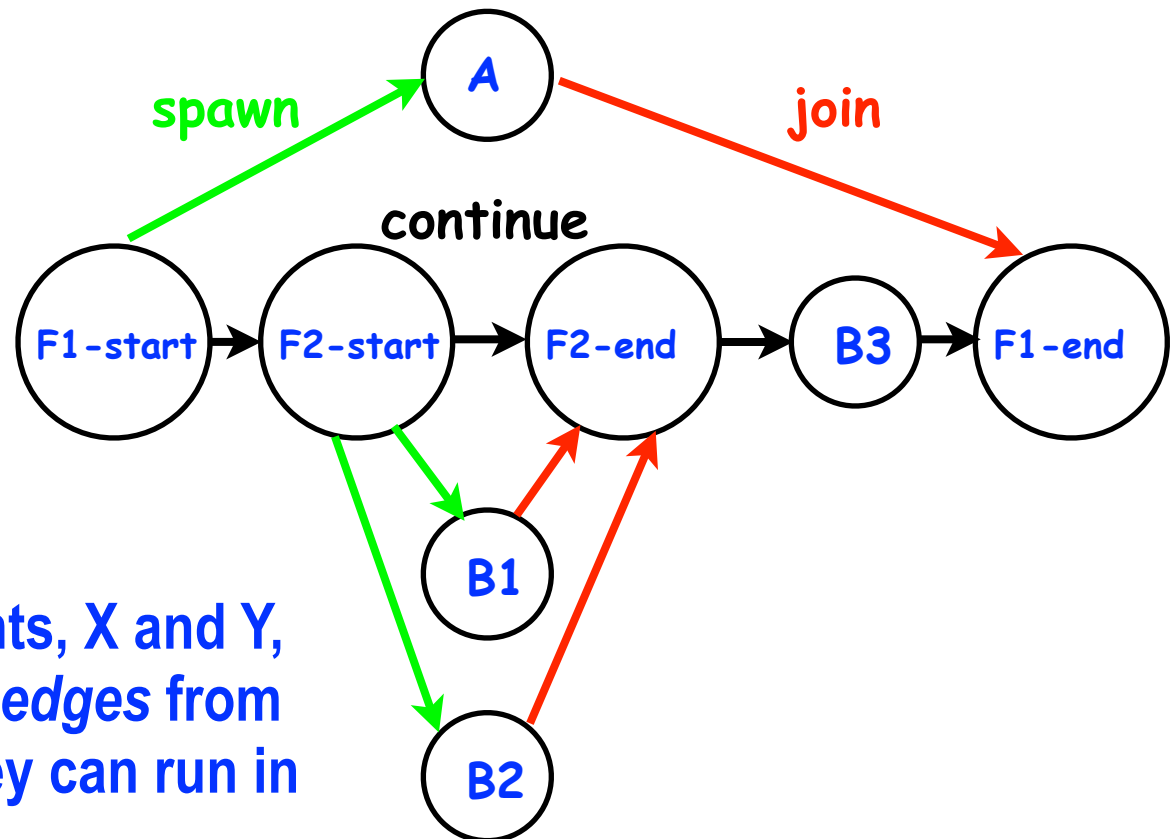

Key idea: If two statements, X and Y, have *no path of directed edges* from one to the other, then they can run in parallel with each other.



Complexity Measures for Computation Graphs

Define

- $\text{TIME}(N)$ = execution time of node N
- $\text{WORK}(G)$ = sum of $\text{TIME}(N)$, for all nodes N in CG G
 - $\text{WORK}(G)$ is the total work to be performed in G
- $\text{CPL}(G)$ = length of a longest path in CG G , when adding up execution times of all nodes in the path
 - Such paths are called *critical paths*
 - $\text{CPL}(G)$ is the length of these paths (critical path length, also referred to as the *span* of the graph)
 - $\text{CPL}(G)$ is also the smallest possible execution time for the computation graph



Which Computation Graph has more ideal parallelism?

Assume that all nodes have $\text{TIME} = 1$, so $\text{WORK} = 10$ for both graphs.

Computation Graph 1

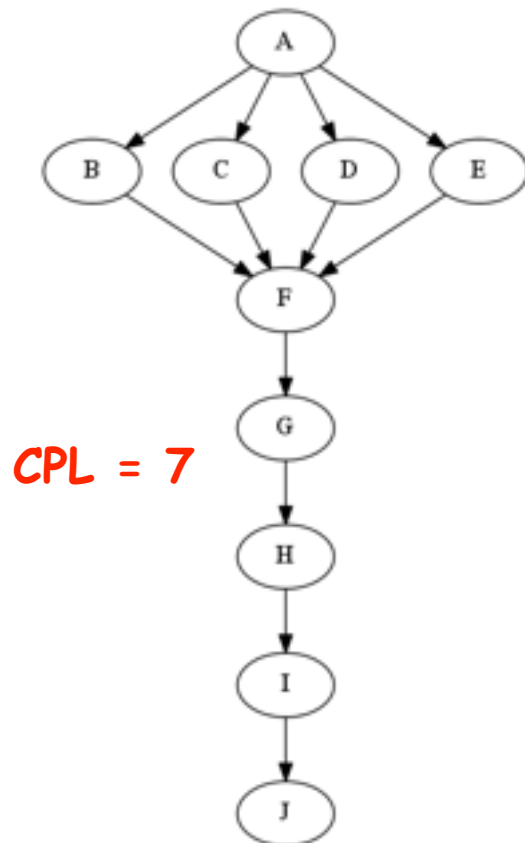

Computation Graph 2

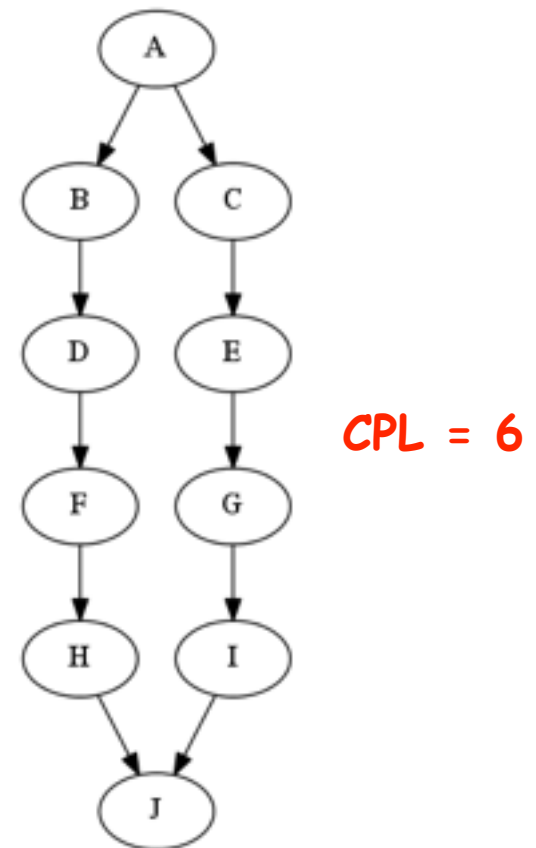

Data Races

A data race occurs on location L in a program execution with computation graph CG if there exist steps (nodes) $S1$ and $S2$ in CG such that:

1. $S1$ does not depend on $S2$ and $S2$ does not depend on $S1$, i.e., $S1$ and $S2$ can potentially execute in parallel, and
 2. Both $S1$ and $S2$ read or write L , and at least one of the accesses is a write.
- A data-race is usually considered an error. The result of a read operation in a data race is undefined. The result of a write operation is undefined if there are two or more writes to the same location.
 - Note that our definition of data race includes the case that both $S1$ and $S2$ write the same value in location L , even if that may not be considered an error.
 - Above definition includes all “potential” data races i.e., we consider it to be a data race even if $S1$ and $S2$ end up executing on the same processor.



One Possible Solution to Worksheet 2 (Reverse Engineering a Computation Graph)

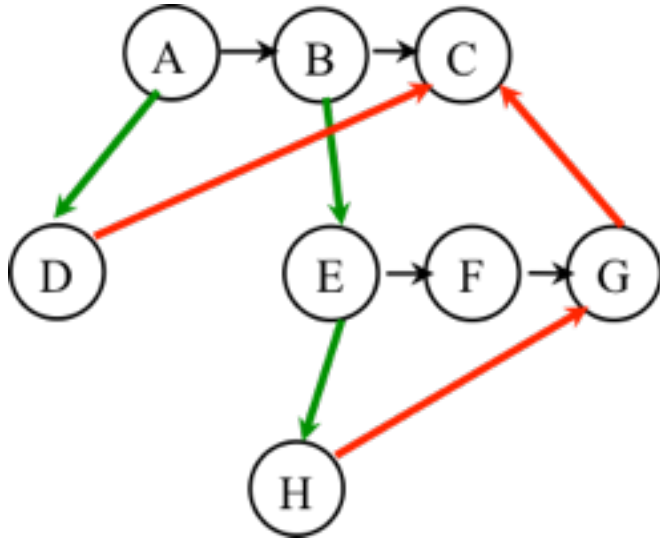

```
1. A() ;
2. finish { // F1
3.   async D() ;
4.   B() ;
5.   async {
6.     E() ;
7.     finish { // F2
8.       async H() ;
9.       F() ;
10.    } // F2
11.   G() ;
12.  }
13. } // F1
14. C() ;
```

Observations:

- Any node with out-degree > 1 must be an **async** (must have an outgoing **spawn edge**)
- Any node with in-degree > 1 must be an **end-finish** (must have an incoming **join edge**)
- Adding or removing transitive edges does not impact ordering constraints



Bounding the performance of Greedy Schedulers (Lecture 3)

Combine lower and upper bounds to get

$$\max(\text{WORK}(G)/P, \text{CPL}(G)) \leq T_p \leq \text{WORK}(G)/P + \text{CPL}(G)$$

Corollary 1: Any greedy scheduler achieves execution time T_p that is within a factor of 2 of the optimal time (since $\max(a,b)$ and $(a+b)$ are within a factor of 2 of each other, for any $a \geq 0, b \geq 0$).

Corollary 2: Lower and upper bounds approach the same value whenever

- There's lots of parallelism, $\text{WORK}(G)/\text{CPL}(G) \gg P$
- Or there's little parallelism, $\text{WORK}(G)/\text{CPL}(G) \ll P$



Abstract Performance Metrics

- **Basic Idea**
 - Count operations of interest, as in big-O analysis, to evaluate parallel algorithms
 - Abstraction ignores many overheads that occur on real systems
- **Calls to doWork()**
 - Programmer inserts calls of the form, `doWork(N)`, within a step to indicate abstraction execution of N application-specific abstract operation
 - e.g., in the Homework 1 programming assignment (Parallel Sort), we will include one call to `doWork(1)` in each call to `compareTo()`, and ignore the cost of everything else
- Abstract metrics are enabled by calling `HjSystemProperty.abstractMetrics.set(true)` at start of program execution
- If an HJ program is executed with this option, abstract metrics can be printed at end of program execution with calls to `abstractMetrics().totalWork()`, `abstractMetrics().criticalPathLength()`, and `abstractMetrics().idealParallelism()`



One Possible Solution to Worksheet 3 (Multiprocessor Scheduling)

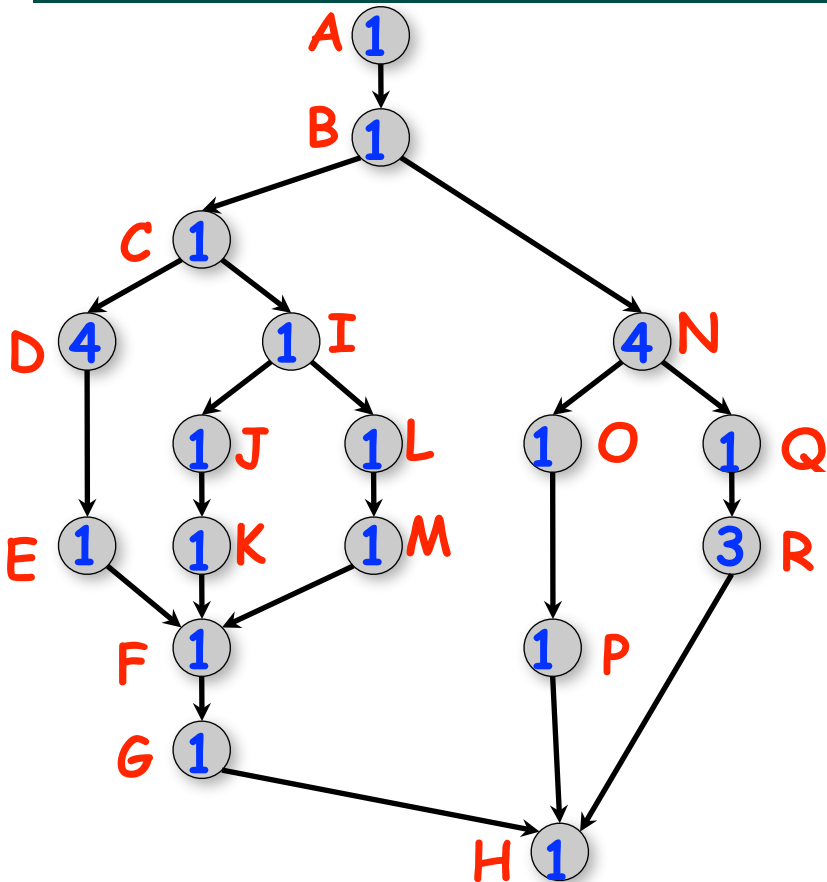

There are
4 idle
slots in
this
schedule
— can we
do better
than $T_2 = 15$?

Start time	Proc 1	Proc 2
0	A	
1	B	
2	C	N
3	D	N
4	D	N
5	D	N
6	D	O
7	I	Q
8	J	R
9	L	R
10	K	R
11	M	E
12	F	P
13	G	
14	H	
15		

- As before, $WORK = 26$ and $CPL = 11$ for this graph
- $T_2 = 15$, for the 2-processor schedule on the right
- We can also see that

$$\max(CPL, WORK/2) \leq T_2 < CPL + WORK/2$$



Solution to Worksheet 4

- Estimate $T(S,P) \sim \text{WORK}(G,S)/P + \text{CPL}(G,S) = (S-1)/P + \log_2(S)$ for the parallel array sum computation shown in slide 4.
- Assume $S = 1024 \implies \log_2(S) = 10$
- Compute for 10, 100, 1000 processors
 - $T(P) = 1023/P + 10$
 - $\text{Speedup}(10) = T(1)/T(10) = 1033/112.3 \sim 9.2$
 - $\text{Speedup}(100) = T(1)/T(100) = 1033/20.2 \sim 51.1$
 - $\text{Speedup}(1000) = T(1)/T(1000) = 1033/11.0 \sim 93.7$
- Why does the speedup not increase linearly in proportion to the number of processors?
 - Because of the critical path length, $\log_2(S)$, is a bottleneck



Worksheet 4 - Speedup Chart (linear scale)

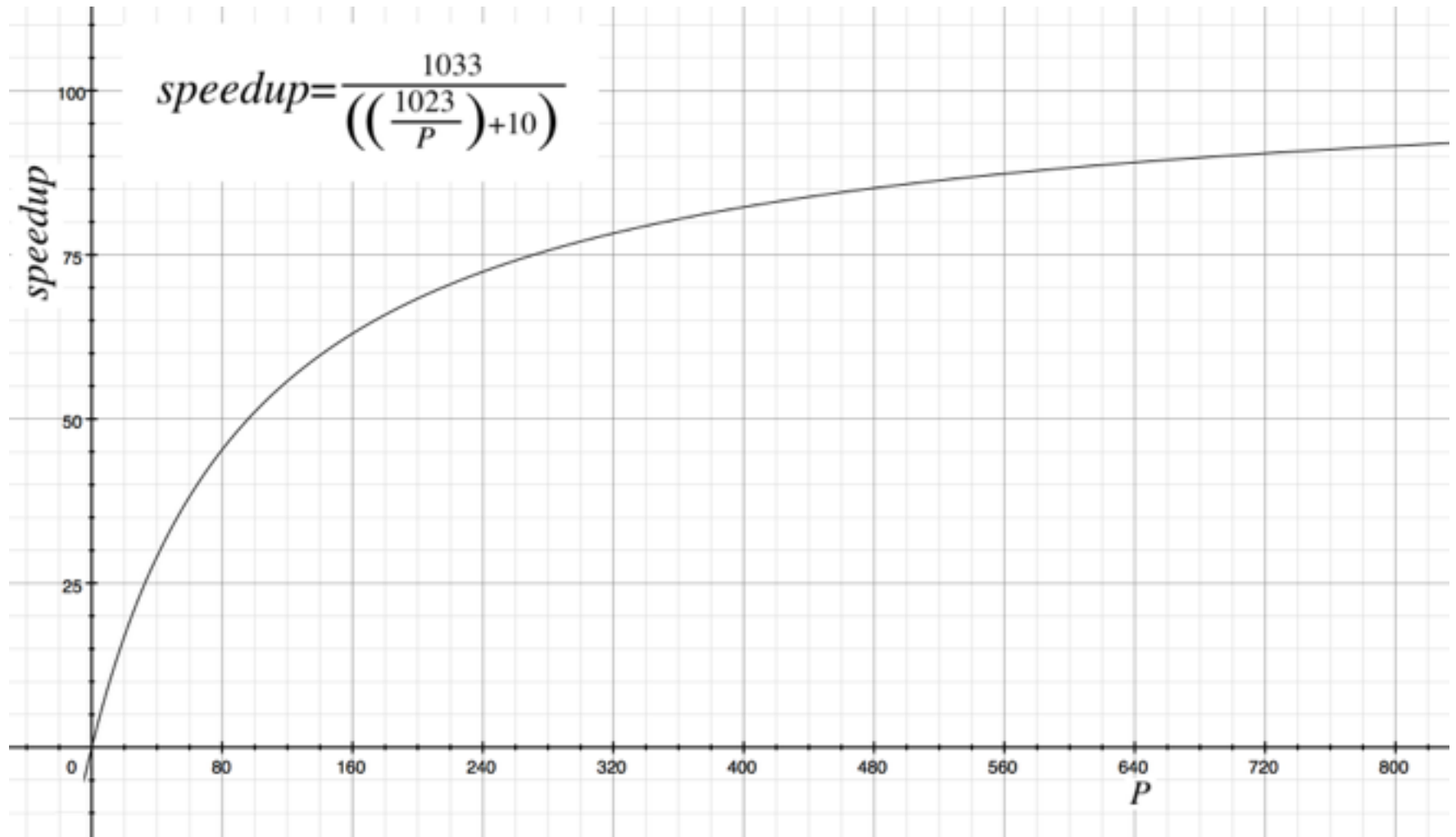

Functional Parallelism: Adding Return Values to Async Tasks (Lecture 5)

Example Scenario (PseudoCode)

```
// Parent task creates child async task
future<Integer> container = future { return computeSum(X,low,mid); };
. . .
// Later, parent examines the return value
Integer sum = container.get();
```

Two issues to be addressed:

- 1) Distinction between **container** and **value** in container (box)
- 2) Synchronization to avoid race condition in container accesses

Parent Task

```
container = future {...}
. . .
container.get()
```

Child Task

```
computeSum(...)
return ...
```

container → **return value**



Worksheet #5 solution: Computation Graphs for Async-Finish and Future Constructs

1) Can you write pseudocode with async-finish constructs that generates a Computation Graph with the same ordering constraints as the graph on the right? If so, provide a sketch of the program.

No. Finish cannot be used to ensure that D waits for both B and C, while E waits only for C.

2) Can you write pseudocode with future async-get constructs that generates a Computation Graph with the same ordering constraints as the graph on the right? If so, provide a sketch of the program.

Yes, see program sketch with void futures. A dummy return value can also be used.

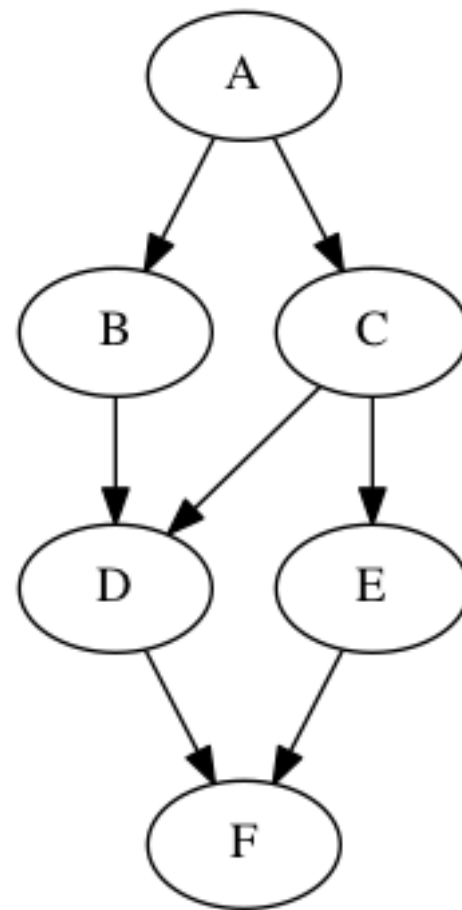

Worksheet #5 solution (contd)

```
1. HjFuture<String> A = future(() -> {
2.     return "A"; });
3. HjFuture<String> B = future(() -> {
4.     A.get(); return "B"; });
5. HjFuture<String> C = future(() -> {
6.     A.get(); return "C"; });
7. HjFuture<String> D = future(() -> {
8.     // Order of B.get() & C.get() doesn't matter
9.     B.get(); C.get(); return "D"; });
10. HjFuture<String> E = future(() -> {
11.     C.get(); return "E"; });
12. HjFuture<String> F = future(() -> {
13.     D.get(); E.get(); return "F"; });
14. F.get();
```

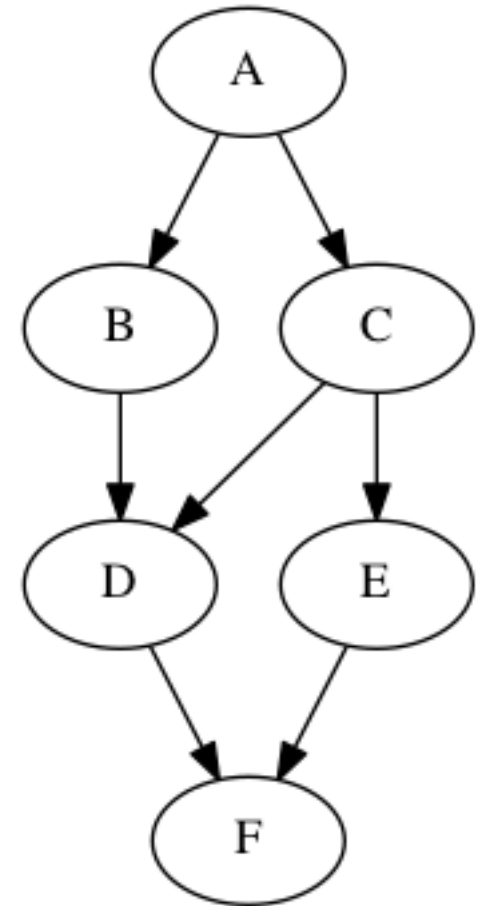

Extending Finish Construct with “Finish Accumulators” (Lecture 7)

- Creation

```
accumulator ac = newFinishAccumulator(operator, type);
```

— Operator must be associative and commutative (creating task “owns” accumulator)

- Registration

```
finish (ac1, ac2, ...) { ... }
```

— Accumulators *ac1*, *ac2*, ... are registered with the finish scope

- Accumulation

```
ac.put(data);
```

— Can be performed in parallel by any statement in finish scope that registers *ac*. Note that a *put* contributes to the accumulator, but does not overwrite it.

- Retrieval

```
ac.get(); // Deterministic operation
```

— Returns initial value if called before end-finish, or final value after end-finish

— *get()* is nonblocking because no synchronization is needed (finish provides the necessary synchronization)



REMINDER: computation structure of $C(4,2)$

Nodes with calls to `ComputeSum()` are in red

$$C(n, k) =$$

$$C(n-1, k-1) + C(n-1, k)$$

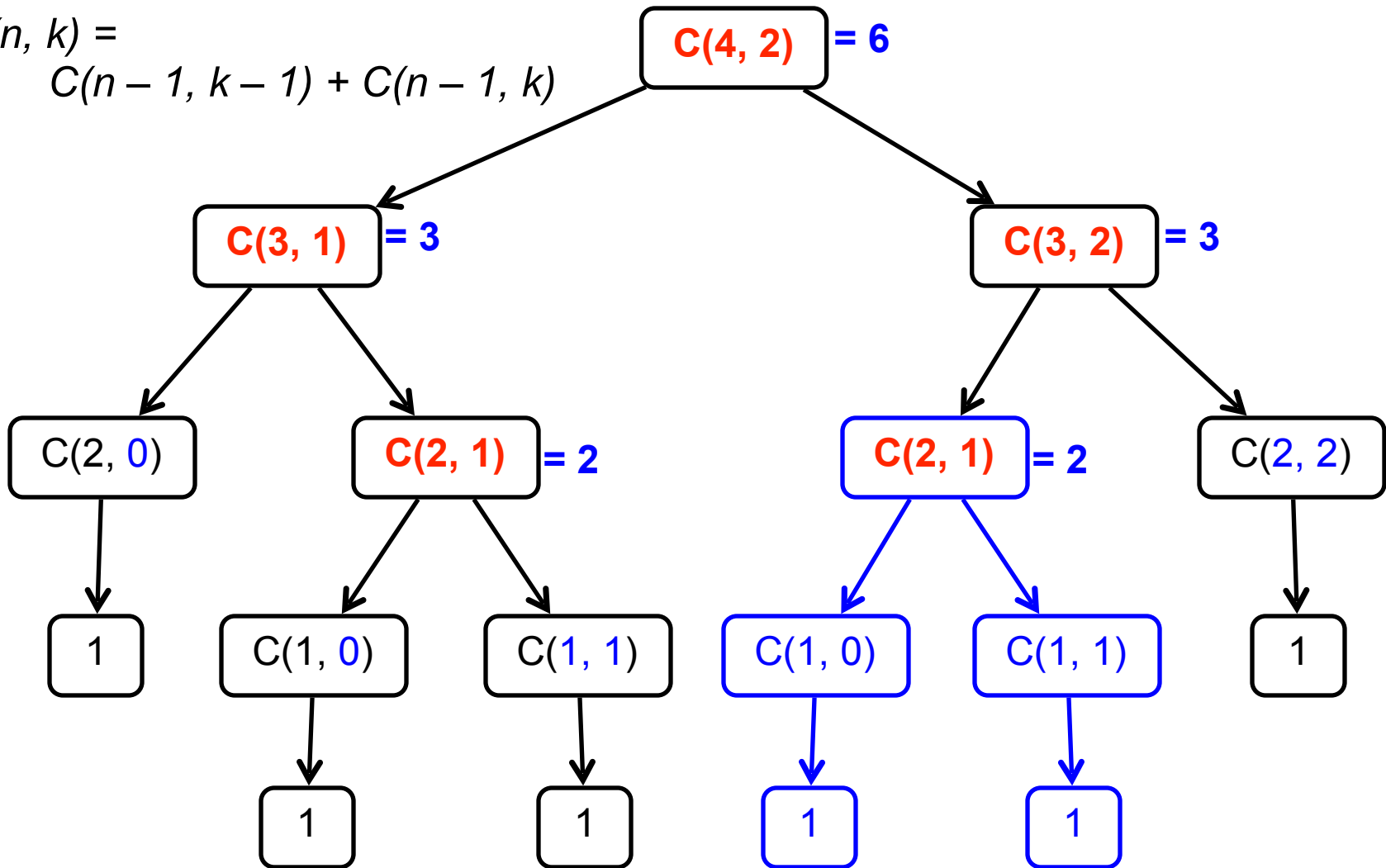

Error Conditions with Finish Accumulators

1. Non-owner task cannot access accumulator outside registered finish

```
// T1 allocates accumulator a
accumulator a = newFinishAccumulator(...);
a.put(1); // T1 can access a
async { // T2 cannot access a
  a.put(1); Number v1 = a.get();
}
```

2. Non-owner task cannot register accumulator with a finish

```
// T1 allocates accumulator a
accumulator a = newFinishAccumulator(...);
async {
  // T2 cannot register a with finish
  finish (a) { async a.put(1); }
}
```



Worksheet #7 solution: Associativity and Commutativity

Recap:

A binary function f is *associative* if $f(f(x,y),z) = f(x,f(y,z))$.

A binary function f is *commutative* if $f(x,y) = f(y,x)$.

Worksheet problems:

1) Claim: a Finish Accumulator (FA) can only be used with operators that are *associative and commutative*. Why? What can go wrong with accumulators if the operator is non-associative or non-commutative?

You may get different answers in different executions if the operator is non-associative or non-commutative e.g., an accumulator can be implemented using one “partial accumulator” per processor core.

2) For each of the following functions, indicate if it is associative and/or commutative.

a) $f(x,y) = x+y$, for integers x, y , is *associative and commutative*

b) $g(x,y) = (x+y)/2$, for integers x, y , is *commutative but not associative*

⇒ *Incorrect answers found in some worksheets: Associative / Both / Neither*

c) $h(s1,s2) = \text{concat}(s1, s2)$ for strings $s1, s2$, e.g., $h(\text{“ab”}, \text{“cd”}) = \text{“abcd”}$, is *associative but not commutative*

⇒ *Incorrect answers found in some worksheets: Commutative / Neither*



Memoization (Lecture 8)

- Memoization - saving and reusing previously computed values of a function rather than recomputing them
 - A optimization technique with space-time tradeoff
- A function can only be memoized if it is *referentially transparent*, i.e. functional
- Related to caching
 - memoized function "remembers" the results corresponding to some set of specific inputs
 - memoized function populates its cache of results transparently on the fly, as needed, rather than in advance

Helpful Link: <http://en.wikipedia.org/wiki/Memoization>



Map Reduce: Summary (Lecture 8)

- Input set is of the form $\{(k_1, v_1), \dots, (k_n, v_n)\}$, where (k_i, v_i) consists of a key, k_i , and a value, v_i .
 - Assume that the key and value objects are immutable, and that equality comparison is well defined on all key objects.
- Map function f generates sets of intermediate key-value pairs, $f(k_i, v_i) = \{(k_1', v_1'), \dots, (k_m', v_m')\}$. The k_j' keys can be different from k_i key in the in of the map function.
 - Assume that a flatten operation is performed as a post-pass after the map operations, so as to avoid dealing with a set of sets.
- Reduce operation groups together intermediate key-value pairs, $\{(k', v_j')\}$ with the same k' , and generates a reduced key-value pair, (k', v'') , for each such k' , using reduce function g



Worksheet #8: Analysis of Map Reduce Example

Analyze the total WORK and CPL for the Map reduce example:

- Assume that each Map step has WORK = number of input words, and CPL=1
- Assume that each Reduce step has WORK = number of input word-count pairs, and CPL = $\log_2(\# \text{ occurrences for input word with largest } \# \text{ pairs})$

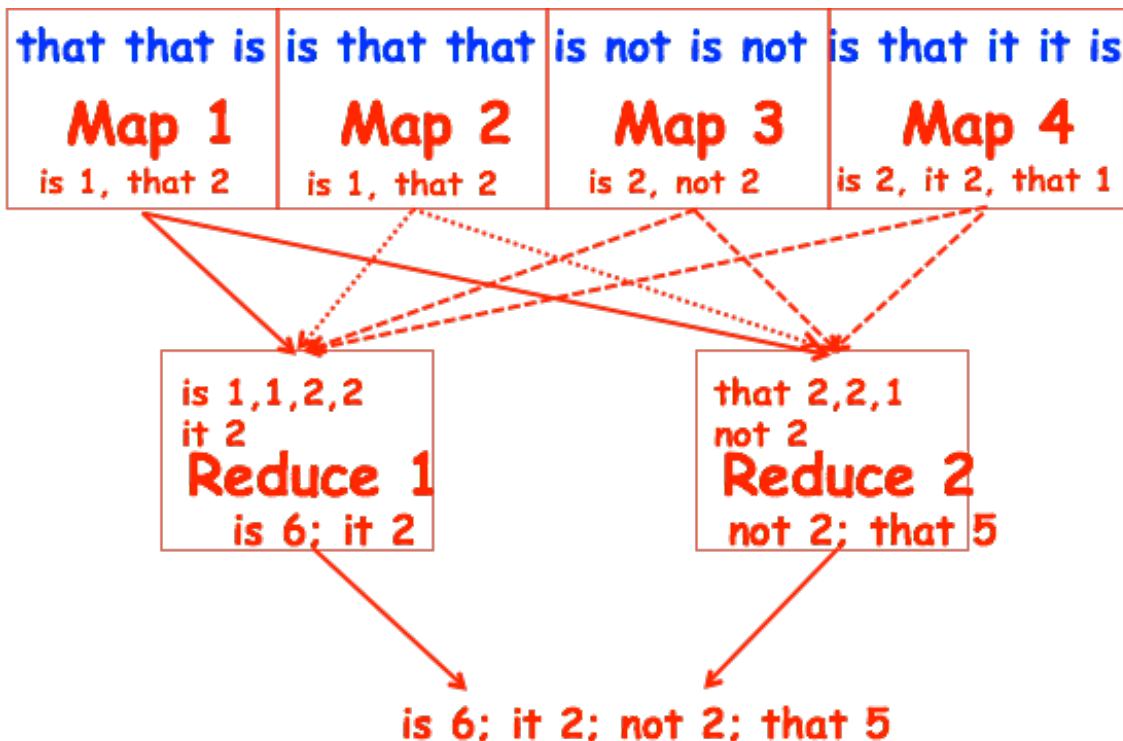

WORK/CPL for all Map steps:

- WORK = 15
- CPL = 1 (ignore impact of local sums on CPL)

WORK/CPL for Reduce 1 step:

- WORK = 5
- CPL = $\text{ceiling}(\log_2(4)) = 2$

WORK/CPL for Reduce 2 step:

- WORK = 4
- CPL = $\text{ceiling}(\log_2(3)) = 2$

Total WORK and CPL

- WORK = $15 + 5 + 4 = 24$
- CPL = $1 + 2 = 3$



Functional vs. Structural Determinism (Lecture 9)

- A parallel program is said to be *functionally deterministic* if it always computes the same answer when given the same input
- A parallel program is said to be *structurally deterministic* if it always produces the same computation graph when given the same input
- *Data-Race-Free Determinism Property*
 - If a parallel program is written using the constructs learned so far (finish, async, futures) *and* is known to be data-race-free, *then it must be both functionally deterministic and structurally deterministic*



Worksheet #9: Classifying different versions of parallel search algorithm

Enter “YES” or “NO”, as appropriate, in each box below

Example: String Search variation	Data Race Free?	Functionally Deterministic?	Structurally Deterministic?
V1: Count of all occurrences	YES	YES	YES
V2: Existence of an occurrence	NO	YES	YES
V3: Index of any occurrence	NO	NO	YES
V4: Optimized existence of an occurrence: do not create more async tasks after occurrence is found	NO	YES	NO
V5: Optimized index of any occurrence: do not create more async tasks after occurrence is found	NO	NO	NO



One-Dimensional Iterative Averaging Example (Lecture 11)

- Initialize a one-dimensional array of $(n+2)$ double's with boundary conditions, $\text{myVal}[0] = 0$ and $\text{myVal}[n+1] = 1$.
- In each iteration, each interior element $\text{myVal}[i]$ in $1..n$ is replaced by the average of its left and right neighbors.
 - Two separate arrays are used in each iteration, one for old values and the other for the new values
- After a sufficient number of iterations, we expect each element of the array to converge to $\text{myVal}[i] = (\text{myVal}[i-1] + \text{myVal}[i+1])/2$, for all i in $1..n$

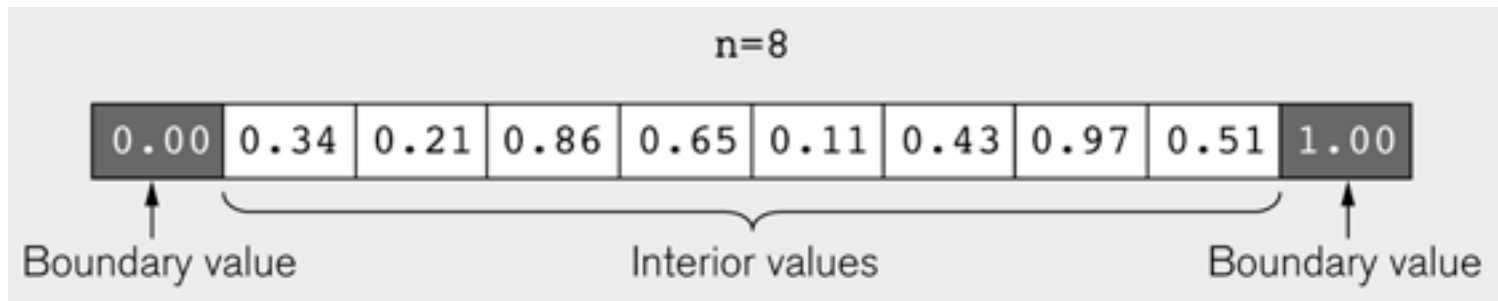

Illustration of an intermediate step for $n = 8$ (source: Figure 6.19 in Lin-Snyder book)



HJ code for One-Dimensional Iterative Averaging using nested forseq-forall structure

```
1. float[] myVal = new float[n+2];
2. float[] myNew = new float[n+2];
3. ... // Intialize myVal, m, n
4. forseq(0, m-1, (iter) -> {
5.     // Compute MyNew as function of input array MyVal
6.     forall(1, n, (j) -> { // Create n tasks
7.         myNew[j] = (myVal[j-1] + myVal[j+1])/2.0;
8.     }); // forall
9.     // What is the purpose of line 10 below?
10. float[] temp=myVal; myVal=myNew; myNew=temp;
11. // myNew becomes input array for next iteration
12. }); // for
```



Solution to Worksheet #11: One-dimensional Iterative Averaging Example

1) Assuming $n=9$ and the input array below, perform a “half-iteration” of the iterative averaging example by only filling in the blanks for odd values of j in the `myNew[]` array (different from the real algorithm). Recall that the computation is “`myNew[j] = (myVal[j-1] + myVal[j+1])/2.0;`”

index, j	0	1	2	3	4	5	6	7	8	9	10
myVal	0	0	0.2	0	0.4	0	0.6	0	0.8	0	1
myNew	0	0.1	0.2	0.3	0.4	0.5	0.6	0.7	0.8	0.9	1

2) Will the contents of `myVal[]` and `myNew[]` change in further iterations?
No, this represents the converged value (equilibrium/fixpoint).

3) Write the formula for the final value of `myNew[i]` as a function of i and n . In general, this is the value that we will get if m (= #iterations in sequential for-iter loop) is large enough.

After a sufficiently large number of iterations, the iterated averaging code will converge with $\text{myNew}[i] = \text{myVal}[i] = i / (n+1)$



Barriers (Lecture 12)

- Question: how can we transform this code so as to ensure that all tasks say hello before any tasks say goodbye, without having to change local ?

- Approach 2: insert a “barrier” (“next” statement) between the hello’s and goodbye’s

1. // APPROACH 2

2. forallPhased (0, m - 1, (i) -> {

3. int sq = i*i;

4. System.out.println(“Hello from task with square = “ + sq);

5. next(); // Barrier

6. System.out.println(“Goodbye from task with square = “ + sq);

7. });

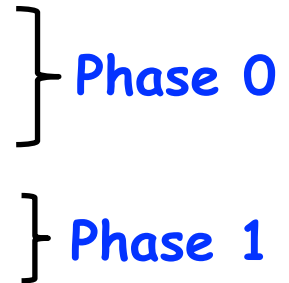

- **next** → each forallPhased iteration waits at barrier until all iterations arrive (previous phase is completed), after which the next phase can start

—Scope of next is the closest enclosing forallPhased statement

—If a forallPhased iteration terminates before executing “next”, then the other iterations don’t wait for it



Worksheet #12: Forall Loops and Barriers

Draw a “barrier matching” figure similar to lecture 12 slide 11 for the code fragment below.

```
1. String[] a = { "ab", "cde", "f" };
2. ... int m = a.length; ...
3. forallPhased (0, m-1, (i) -> {
4.   for (int j = 0; j < a[i].length(); j++) {
5.     // forall iteration i is executing phase j
6.     System.out.println("(" + i + "," + j + ")");
7.     next();
8.   }
9. });
```

Solution

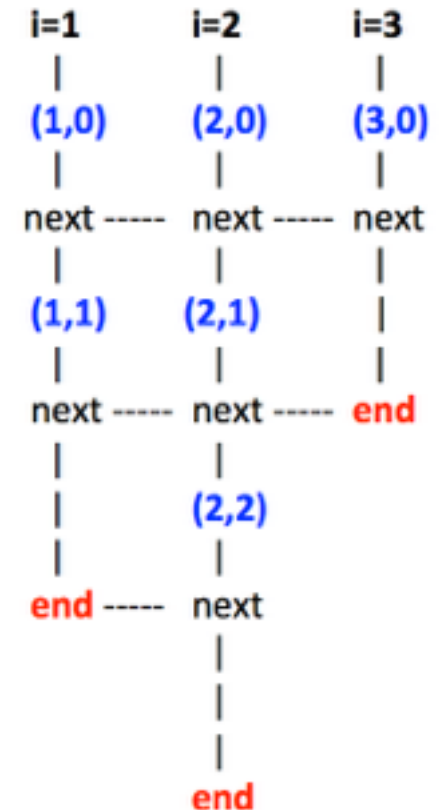

Converting forseq-forall version into a forall-forseq version with barriers (Lecture 14)

```
1. double[] gVal=new double[n+2]; gVal[n+1] = 1;
2. double[] gNew=new double[n+2];
3. forallPhased(1, n, (j) -> { // Create n tasks
4.     // Initialize myVal and myNew as local pointers
5.     double[] myVal = gVal; double[] myNew = gNew;
6.     forseq(0, m-1, (iter) -> {
7.         // Compute MyNew as function of input array MyVal
8.         myNew[j] = (myVal[j-1] + myVal[j+1])/2.0;
9.         next(); // Barrier before next iteration of iter loop
10.        // Swap local pointers, myVal and myNew
11.        double[] temp=myVal; myVal=myNew; myNew=temp;
12.        // myNew becomes input array for next iteration
13.    }); // forseq
14. }); // forall
```



Worksheet #14 Solution: Iterative Averaging Revisited

Answer the questions in the table below for the versions of the Iterative Averaging code shown in slides 7, 8, 10, 12. Write in your answers as functions of m , n , and nc .

	Slide 7	Slide 8	Slide 10	Slide 12
How many tasks are created (excluding the main program task)?	$m*n$	n Incorrect: $n * m$	$m*nc$ Incorrect: $n * nc$	nc Incorrect: $n*m, m*nc$
How many barrier operations (calls to next per task) are performed?	0 Incorrect: m	m Incorrect: $m*n$	0 Incorrect: m	m Incorrect: $m*nc, nc$

The SPMD version in slide 12 is the most efficient because it only creates nc tasks. (Task creation is more expensive than a barrier operation.)



Extending HJ Futures for Macro-Dataflow: Data-Driven Futures (Lecture 15)

```
HjDataDrivenFuture<T1> ddfA = newDataDrivenFuture();
```

- Allocate an instance of a data-driven-future object (container)
- Object in container must be of type T1, and can only be assigned once via put() operations
- HjDataDrivenFuture extends the HjFuture interface

```
ddfA.put(V) ;
```

- Store object V (of type T1) in ddfA, thereby making ddfA available
- Single-assignment rule: at most one put is permitted on a given DDF



Extending HJ Futures for Macro-Dataflow: Data-Driven Tasks

```
asyncAwait(ddfA, ddfB, ..., () -> Stmt);
```

- Create a new data-driven-task to start executing **Stmt** after all data-driven futures **ddfA, ddfB, ...** become available (i.e., after task becomes “enabled”)
- Await clause can be used to implement “nodes” and “edges” in a computation graph

ddfA.get()

- Return value (of type T1) stored in **ddfA**
- Throws an exception if put() has not been performed
 - Should be performed by async’s that contain **ddfA** in their await clause, or if there’s some other synchronization to guarantee that the put() was performed



Worksheet 15a: Data Driven Futures

Name: _____

Netid: _____

For the example below, will reordering the five `async` statements change the meaning of the program (assuming that the semantics of the reader/writer methods depends only on their parameters)? If so, show two orderings that exhibit different behaviors. If not, explain why not.

No, reordering the `asyncs` doesn't change the meaning of the problem. Regardless of the order, Task 3 will always wait on Task 1. Task 5 will always wait on Task 2. Task 4 will always wait on both Task 1 and 2.

```
1. DataDrivenFuture left = new DataDrivenFuture();
2. DataDrivenFuture right = new DataDrivenFuture();
3. finish {
4.     async await(left) leftReader(left); // Task3
5.     async await(right) rightReader(right); // Task5
6.     async await(left, right)
7.         bothReader(left, right); // Task4
8.     async left.put(leftWriter()); // Task1
9.     async right.put(rightWriter()); // Task2
10. }
```



Summary of Phaser Construct (Lecture 15)

- Phaser allocation
 - `HjPhaser ph = newPhaser(mode);`
 - Phaser `ph` is allocated with registration mode
 - Phaser lifetime is limited to scope of Immediately Enclosing Finish (IEF)
- Registration Modes
 - `HjPhaserMode.SIG`, `HjPhaserMode.WAIT`,
`HjPhaserMode.SIG_WAIT`, `HjPhaserMode.SIG_WAIT_SINGLE`
 - NOTE: phaser `WAIT` is unrelated to Java `wait/notify` (which we will study later)
- Phaser registration
 - `asyncPhased (ph1.inMode(<mode1>), ph2.inMode(<mode2>), ... () -> <stmt>)`
 - Spawned task is registered with `ph1` in `mode1`, `ph2` in `mode2`, ...
 - Child task's capabilities must be *subset* of parent's
 - `asyncPhased <stmt>` propagates all of parent's phaser registrations to child
- Synchronization
 - `next();`
 - Advance each phaser that current task is registered on to its next phase
 - Semantics depends on registration mode
 - Barrier is a special case of phaser, which is why `next` is used for both



Solution to Worksheet #15b: Left-Right Neighbor Synchronization using Phasers

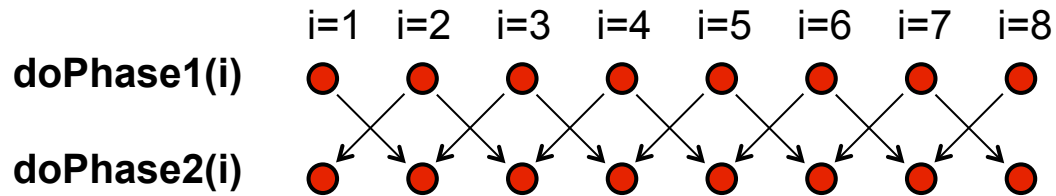

Complete the phased clause below to implement the left-right neighbor synchronization shown above.

```
1. finish (() -> {
2.   final HjPhaser[] ph =
       new HjPhaser[m+2]; // array of phaser objects
3.   forseq(0, m+1, (i) -> { ph[i] = newPhaser(SIG_WAIT) });
4.   forseq(1, m, (i) -> {
5.     asyncPhased(
       ph[i-1].inMode(WAIT),
       ph[i].inMode(SIG),
       ph[i+1].inMode(WAIT), () -> {
6.       doPhase1(i);
7.       next();
8.       doPhase2(i); }); // asyncPhased
9.   }); // forseq
10.}); // finish
```

NOTE: Task-to-
phaser mappings can be
many-to-many in general. In
general, it is important to
understand the difference between
computation tasks (async's) and
synchronization objects
(phasers).



Summary of Parallel Programming Constructs you've learned so far

- **Task Parallelism (Unit 1)**
 - Async (task creation)
 - Finish (structured task termination)
- **Functional Parallelism (Unit 2)**
 - Future (task creation)
 - Future get() (task termination with return value)
 - Accumulators (functional reduction)
 - Map-Reduce (functional parallelism & reduction on key-value pairs)
- **Loop Parallelism (Unit 3)**
 - Forall (parallel loops)
 - Barriers (all-to-all synchronization)
- **Dataflow Parallelism (Unit 4)**
 - Data-Driven Tasks (dataflow parallelism)
 - Phasers (point-to-point synchronization)
 - Phaser-specific next operations



Midterm exam (Exam 1)

- Midterm exam (Exam 1) will be held during COMP 322 lab time at 4pm on Thursday, February 21, 2019
 - Closed-notes, closed-book, written exam scheduled for 2.5 hours during 4pm – 6:30pm (but you can leave early if you're done early!)
 - Lastname: A-L (Herring Hall 100), M-Z (Duncan Hall, McMurtry Auditorium)
 - The exam will be in Canvas AND on paper. You are allowed to use your laptop ONLY to enter your answers in Canvas, nothing else
 - Scope of exam is limited to Lectures 1 - 16 (all topics in Module 1 handout)
 - Since this is a written exam and not a programming assignment, syntactic errors in program text will not be penalized (e.g., missing semicolons, incorrect spelling of keywords, etc) so long as the meaning of your solution is unambiguous.
 - If you believe there is any ambiguity or inconsistency in a question, you should state the ambiguity or inconsistency that you see, as well as any assumptions that you make to resolve it.

